

**51st Edition**

**School Bus Driver International  
Safety Competition**

**Driver and Competition Handbook**



**June 28 - 29, 2025**

**Austin Marriott Downtown - Hays CISD**  
**Austin, TX**

**CONTENTS:**

2025 ELIGIBILITY REQUIREMENTS..... 2

REGULATIONS..... 5

DISQUALIFICATIONS..... 6

**COMPETITION EVENTS:**

GENERAL KNOWLEDGE WRITTEN TEST ..... 8

VEHICLE INSPECTION WRITTEN TEST ..... 8

OFFSET ALLEY EVENT ..... 9

RAILROAD GRADE CROSSING - RIGHT TURN EVENT..... 14

STRAIGHT LINE EVENT..... 19

DIMINISHING CLEARANCE EVENT ..... 22

BACK UP STALL EVENT ..... 25

LEFT TURN EVENT..... 30

PARALLEL PARKING EVENT ..... 33

CURB LINE STUDENT LOADING ZONE EVENT..... 37

STOP LINE EVENT ..... 41

SUPRISE EVENT..... 43

BUS MEASURING POINT CHART ..... 44

PAST CHAMPIONS..... 45

# 50th Edition School Bus Driver International Safety Competition

## 2025 ELIGIBILITY REQUIREMENTS

**Purpose** - The purpose of the School Bus Driver International Safety Competition (SBDISC or Competition), sponsored by the National School Transportation Association (NSTA), is to showcase the best school bus drivers in North America to school administrators, teachers, parents, students, school boards and the general public. State and Provinces are challenged to develop eligibility requirements that ensure their contestants meet this objective. It also presents an opportunity to present the profession in a positive light in news and social media.

**Multistate competitions** - A state/province holding a School Bus Driver Safety Competition may issue an invitation to one or more adjoining states to participate in their competition. Each state/province participating will be eligible to enter drivers in the School Bus Driver International Safety Competition if they qualify under SBDISC eligibility requirements. The Multistate/Provincial competition must have a single competition that includes both the public and private sectors. Each State or Province meeting these criteria must have no less than six (6) contestants competing in each school bus class (if offered).

### **ELGIIILITY REQUIREMENTS (Please Read Carefully):**

- 1. The SBDISC will be limited to a maximum of 100 contestants based on date of entries unless the approved competition has reserved space prior to the date of competition. (See # 15)*
- 2. Each State/Provincial/Multistate Competition is allowed a maximum of two {2} contestants in each school bus class not to exceed a total of six (6) contestants per competition as follows:*
  - a. Transit Class - Type D: One (1) public sector driver and one (1) private sector driver for a total of two (2) drivers;*
  - b. Conventional Class - Type C: One (1) public sector driver and one (1) private sector driver for a total of two (2) drivers;*
  - c. Small Bus Class - Type A: One (1) public sector driver and one (1) private sector driver for a total of 2 drivers.*
- 3. A driver may only enter one class of competition and/or one sector, public or private. For example, if a driver/contestant competes for a public or private sector company at the state/provincial level and becomes eligible to advance to the SBDISC, they must compete for the same public or private carrier that they were employed at the time they qualified at the state level. If they change employers after the Sate/Provincial/Multistate Competition and prior to SBDISC they will not be able to compete.*
- 4. Each state/provincial/multistate having competition for conventional, transit and small bus may enter one public and one private sector in each school bus class. The highest score in each school bus for a public sector carrier and the highest score in each school bus class for a private carrier are eligible to compete in the international competition. Example: If the highest score in a school bus class in either sector (public or private) is not within the top 10 places in the competition but is highest overall score in a specific*

*school bus class for that sector (public or private), the individual with the highest score would be eligible to compete in International Competition.*

5. *The State/Provincial/Multistate Competition must include a driving course component in the competition. A driver who competes only in a local district competition, but not in a State/Provincial/Multistate competition is not eligible to register or participate.*

6. *In States or Provinces where the public sector or private sector holds separate competitions, the individual with the highest score from the state or provincial competition in each school bus class will be eligible to compete. If the contestant with the highest score in their respective class, public or private, is unable to participate, the next highest score in that class may be eligible.*

7. *In the case of a single competition, one winner in the same class, public or private, will be allowed to participate representing the state or province. In the case of a private or public competition, information must be provided that the competition was open to all private or public sector participants in the state or province and properly advertised. If a state or province has only a public sector competition, they will be limited to a maximum of three (3) public sector contestants, one for each school bus class. The same would apply to private sector competition.*

8. *In order for a contestant to be accepted, NSTA must be provided the information of the date, location and a list by name, score and employer of the three highest score in the public and the same information for the private sector in each school bus class. Drivers/contestants will not be approved for competition, until this documentation is submitted by the appropriate State or Provincial Agency/Association or State/Provincial/Multistate Competition Chairperson.*

9. *In order to qualify for participation in the Competition, a driver must hold a valid Commercial Driver License (CDL) and meet any other licensing and/or certification requirements for a school bus driver from the State or Province where he or she is employed. In addition, he/she must not have had a preventable school bus accident (as defined below) since September 1, 2022.*

*Definition of a Preventable Accident) "An occurrence involving an employer owned or leased vehicle that results in an accident in which the driver in question failed to exercise every reasonable precaution to prevent it."*

10. *No public entity or private entity winner will be eligible unless he/she meets the above criteria for State/Provincial Competition during the past year.*

11. *A contestant must enter the school bus class of competition in which he/she competed in during the state/provincial/multistate competition.*

12. *All contestants must report to the competition registration desk between 2:00 PM and 5:00 PM (CT) on Saturday June 28, 2025. Contestant must report for orientation and testing by 6:00 PM (CT) on Saturday June 28, 2025. All contestants must report by 7:00 a.m. on June 29, 2025, for driving competition. Registration and testing must be completed prior to 7:00 AM (CT) on June 29, 2025, to compete.*

Registration and testing will be at the Austin Marriott Downtown, unless contestants are otherwise instructed prior to the Competition.

13. The location of the driving competition and shuttles will be announced at Competition contestant orientation on Saturday, June 28, 2025.

14. The registration fee for each contestant is \$175.00 (U.S. Currency). Please do not send your payment until your eligibility is confirmed. The fee will be refunded if the contest is unable to attend, if NSTA is notified no later than June 15, 2025.

15. State/Provincial/Multistate Competitions scheduled after June 1, 2025, may reserve space for its future eligible contestants by notifying the NSTA office. The request must be in writing and request the number spots to be reserved. The request cannot exceed the number of eligible contestants – with a maximum of six (6). The date of competition and name and contact of the State/Provincial/Multistate official contact. If these slots will not be utilized, you must notify NSTA immediately. Failure to do so may make your local Competition ineligible from future participation.

16. *Limited Grandfather Provision:* If an individual in a state or province where a state/provincial/multistate Competition is not held this year (2025) - a previous first-place winner in the 2019 School Bus Driver International Safety Competition can become eligible for participation in the SBDISC in 2025. The state must certify that it did not host a competition in 2025, and they do not object to the driver participating, representing their state in 2025.

17. *DEADLINE* for receiving applications by NSTA officials is June 15, 2025. Contestant applications should be sent to NSTA within two (2) days after the conclusion of the State/Provincial/Multistate Competition. This will help ensure that contestant applications are received by NSTA in advance of the application deadline.

### **NSTA Contact Information:**

**Mailing Address:** P.O. Box 9843, Trenton, NJ 08650

**Overnight Deliveries:** 4573 South Broad St., Suite 200, Yardville, NJ 08620

**Telephone:** 703-684-3200

**General Email:** [Info@yellowbuses.org](mailto:Info@yellowbuses.org)

## REGULATIONS:

Contestants and Judges are expected to register for the Safety Competition in advance and report for the following competition activities:

- Judge's Check-In: 2:00 PM - 2:30 PM (CT) on Saturday, June 28, 2025
- Judge's Orientation: 2:30 PM – 4:00 PM (CT) on Saturday, June 28, 2025
- Driver's Check-In: 3:00 PM – 4:00 PM (CT) on Saturday, June 28, 2025
- Driver's Orientation/Testing: 4:00 PM – 6:00 PM (CT) on Saturday, June 28, 2025
- Driving Competition Pre-Check and Road Course Orientation: Competitors must be available on Sunday, June 29, 2025 at the appointed time for their Category's (Type A, Type C, Type D) Pre-Check and Road Course Orientation. This information will be disseminated at Driver Orientation on Saturday (June 28<sup>th</sup>).
- *Late arrival to any of the above activities may disqualify the contestant. Shuttle buses will be provided from the Austin Marriott Downtown to the competition site. If you wish to drive yourself, driving directions will be provided at Check-In. Please be advised parking will be limited.*
- Pictures and Presentation of Certificates 5:50 PM to 6:30 PM (CT) on Sunday, June 29, 2025.
- Dinner and Awards Banquet 6:30 PM to 9:00 PM (CT) on Sunday, June 29, 2025.

**(All times are Central Time Zone and subject to change)**

1. Contestants will be required to remain in the designated driver preparation area until called for competition. Drivers are not allowed on the course or adjacent area to any of the event stations.
2. Various states/provinces have different laws and regulations; the competition rules will apply, even though they may differ from the laws and regulations that the contestant normally operates under. Competitors qualifying to participate in the 2025 School Bus Driver International Safety Competition are expected to have competed in or practiced in a Safety Competition at the state and/or local level that includes the backup stall event.
3. It is understood that elementary students are on the bus from the time the driver leaves the starting line and the driver must conduct him/herself accordingly.
4. In all events the doors must remained closed unless the rules of an event require the door to be opened.
5. Contestants will drive in the order of the contestant number provided at registration on Saturday, for the school bus class of competition that they entered. If a contestant is not available at the time they are scheduled to drive they may be disqualified. The driver must report to the start line within (5) minutes of the announcement.
6. Each contestant will be allowed a **maximum of six (6) minutes** to familiarize him/herself with the instrumentation and controls of the school bus to be driven in competition. The driver may request assistance, from a competition official, in the adjustment of mirrors and seats within the manufactured specifications.

- 7 The contestant may be timed at selected events. The contestants' accumulated time for the timed events will be used to determine ranking in the case of a tie in the final total score.

No changes will occur on the course set-up once competition starts. However, the Competition Director may disqualify any event during competition and apply the point value equally to all contestants.

- 8 Contestants may contact a representative of the competition committee at the final event in the course, if they feel that an interference or problem affected their competition. If interference or a problem is confirmed and the score of the individual competitor is affected, a determination will be made as to whether to allow a re-run of that event. If a re-run is granted, an official of the competition will escort the competitor directly to the event involved. If a re-run is allowed, the score of the re-run will become the official score and not the previous score that was recorded before the re-run. Any concern must be reported immediately after the competition is completed and before leaving the competition vehicle. The determination by the competition officials will be final relative to the concern. Once the scores have been finalized and winners announced no grievance or changes in the score will occur.
- 9 No scores will be provided prior to the Awards Ceremony on Sunday evening, June 29, 2025. A Scoring Summary will be provided on the NSTA Web site, following the competition. No individual score sheets will be available at the close of the awards presentation.

## DISQUALIFICATIONS:

Any of the following may result in disqualification of a contestant:

1. Any misconduct on the part of a participant or spectator such as the following:
  - Unprofessional behavior
  - Speeding and/or unsafe driving on the course
  - Use of drugs
  - Use of any alcohol during or immediately prior to the competition.
2. Any contestant who knowingly accepts signals from anyone may be automatically disqualified. **No one other than Competition Judges, Committee Members, Safety Competition Officials, and NSTA Staff are allowed on the competition course. Spectators are required to stay in the spectator viewing area and/or public bathroom in the Hays CISD Transportation Facility and are not allowed on the course. (No exceptions)**
3. Failure to maintain proper driving position, (i.e. firmly in the driver's seat, hands on the wheel, etc.)
4. A contestant is not allowed to place his/her head out the window. Make modifications to the driver's seat in any way, other than the manufacturer's standards, that could help the driver, will disqualify the driver and may disqualify any other driver prior to the discovery. Drivers may use a driving cushion. No attachments to the brake or gas pedal will be permitted.

5. Any bus used in competition shall have a mirror system that complies with Federal Motor Vehicle Safety Standard (FMVSS 111). **Mirrors shall be adjusted to provide the driver vision that would normally be required for the safe operation of the vehicle, getting the maximum field of vision and see at least 200 feet to the rear of the bus.** The driver shall not lower their head below the highest point of the steering wheel to adjust the mirrors. Mirrors can only be adjusted within the recommended mirror box standards and not adjusted to just see the ground. During vehicle preparation before competition, drivers may use markers on the ground to adjust the mirrors, such as small cones, rulers, etc. Mirrors shall not be adjusted after being set by the driver and in compliance with FMVSS 111. Any mirror being adjusted after the driver has properly set their mirrors in the bus preparation period will result in disqualification from the Safety Competition.
6. Failure to wear the seat belt properly will disqualify the driver. Placement of the shoulder harness behind the back is not permitted.
7. No smoking, eating or drinking beverages will be allowed during the driving competition.
8. Drivers who fail to operate vehicle with headlights on during competition will be disqualified in the event(s) that the violation occurs.
9. No communication devices of any type will be allowed on the bus during competition or to be operated while driving on the course. (AM, FM, Disk Player, 2-way, CB, cell phones, Bluetooth, Blackberries, etc.)
10. Drivers are required to produce a valid School Bus Driver's License or Certificate required by the State or Province in which they normally operate at the time of registration.
11. Entry into the scoring area by a contestant or driving coach is prohibited.

**(NO COMMUNICATION DEVICES OF ANY KIND ALLOWED IN A COMPETITION SCHOOL BUS)**

**The Competition Committee will make the final determination on any disqualification.**

***COMPETITION EVENTS***

Each of the following sections includes the title of the event, a description of the event, layout instructions and the scoring procedures, including score sheets. The better understanding the contestants have of the information, the more successful they are likely to be during the competition. The sequence of events in this publication is not necessarily the sequence of events in the International Competition; nor will all the events necessarily be included.

**SUMMARY OF POSSIBLE POINTS PER EVENT**

<b>EVENT</b>	<b>POINTS</b>
General Knowledge Written Test	100
Vehicle Inspection Written Test	100
Offset Alley Event	50



Railroad Grade Crossing Right Turn Event	75
Straight Line Event	50
Diminishing Clearance Event	50
Back up Stall Event	50
Left Turn Event	50
Parallel Parking Event	50
Curb Line Student Loading Zone Event	75
Stop Line Event	25
Surprise Event (optional)	50
<b>TOTAL POSSIBLE POINTS</b>	<b>725</b>

## **GENERAL KNOWLEDGE TEST / VEHICLE INSPECTION TEST**

Total Possible Score 200 points

### **PURPOSE OF THE TESTS:**

A school bus driver must be familiar with many laws and regulations, which he/she must faithfully observe. Experts in the school transportation industry have established these laws and regulations over many years. Contestants for the International Competition are encouraged to study their state/province rules, regulations and state laws for school bus drivers. Since many state/province laws and regulations vary, the following documents should be studied for best practices, established by national publications. The driver needs to be knowledgeable in the requirements by law in the daily inspection of the school bus, before transporting students. The test will evaluate the contestants' knowledge of laws regarding pre-trip inspection, as well as the knowledge of vehicle components and knowledge of "why" we check certain items.

Publications to study for the International Competition written test are as follows:

1. **50<sup>th</sup> Annual International School Bus Safety Competition General Information Handbook**  
Available from NSTA at [www.yellowbuses.org/](http://www.yellowbuses.org/) (Safety Competition Tab)
2. **Commercial Driver License Manual (latest publication)**  
Available from your state Motor Vehicle Administration
3. **Operation Lifesaver Publication**

### **INSTRUCTIONS**

This test will be composed of a combination of 50 **essay**, true or false or multiple-choice questions. These statements will be based on the publications mentioned above and on common sense. Examples on the following page are of the general type that will be used.

### **Scoring**

A total time limit of **30 minutes** has been established for the General Knowledge Test/Vehicle Inspection Test. Each test question answered incorrectly or not completed will result in a charge of four demerits for the written test.

Examples of Test Questions:

True

False

1. Smoking is permitted on a school bus when all students are off the bus.

\_\_\_\_\_

\_\_\_\_\_

1. A stop sign means:

- a. Slow down to at least 10 mph
- b. Slow down to at least 5 mph
- c. Proceed cautiously if there is no traffic within 100 yards.
- d. Come to a complete stop.

# OFFSET ALLEY EVENT

Maximum Score: 50 Points

## PURPOSE OF THE EVENT:

This event is designed to evaluate a driver’s ability to handle the bus under actual, and simulated, driving conditions. An offset alley is set up to determine the contestant’s ability to drive his/her bus through the offset lanes with a minimum of hesitation and without touching the barriers or flag tips.

**This is a timed event:** The contestant will be allowed two (2) minutes to complete the event. Time starts when the front bumper enters the first set of barricades and ends when the rear bumper exits the last set of barricades.

**INSTRUCTIONS FOR TYPE C & D BUSES OVER 29 FEET & ALL SMALL TYPE A BUSES:** Two or three sets of parallel barriers, 10 feet long, are set up with flag tips 10 feet apart. The right barrier flag tips of the first set are placed in a direct line with the left barrier flag tips of the second set (the offset barriers), or visa-versa. The distance between any two sets of barriers (from the end of the first set to the beginning of the second set) will be the length of the bus plus three feet for buses over 29 feet long and small Type A buses.

**INSTRUCTIONS FOR TYPE C & D BUSES 29 FEET OR UNDER:** Two or three sets of parallel barriers, 10 feet long, are set up with the flag tips 10 feet apart. The right barrier flag tips of the first set are placed in a direct line with the left barrier flag tips of the second set, or visa-versa. The distance between any two sets of barriers (from the end of the first set to the beginning of the second set) will be the length of the bus plus two feet for buses 29 feet long or under, except small type A buses will be provided three feet.

The direction of the offset (left or right) will be determined by the Competition Director.

## SCORING:

The following demerits will be charged for touching of a flag tip:

1 flag tip	(7 demerits)
2 flag tips	(21 demerits)
3 flag tips	(42 demerits)
4 flag tips	(50 demerits)

For each time of stopping the forward motion of the bus, eight (8) demerits will be charged (not to exceed 16 demerits):

1 time	(8 demerits)
2 times	(16 demerits)

Backing the bus during event	(50 demerits)
Touching a barrier	(50 demerits)

## **Failure to:**

Wear a seat belt	(50 demerits)
Keep door closed during event	(50 demerits)
Drive with headlights on	(50 demerits)
Complete event within the time limit	(50 demerits)

# OFFSET ALLEY TEST

Contestant # \_\_\_\_\_

Event Judge \_\_\_\_\_

Maximum Score: 50 points  
 Demerits: \_\_\_\_\_  
 Score Earned: \_\_\_\_\_

**FAILURE TO:**

Complete event in the 2-minute time limit	(50 demerits)	_____
Drive with the headlights on	(50 demerits)	_____
Wear seat belt properly	(50 demerits)	_____
Keep door closed during event	(50 demerits)	_____

**DEMERITS**

Each instance of stopping forward motion of the bus (8) Max. of (16 demerits) \_\_\_\_\_

For each flag tip touched (1=7) (2=21) (3=42) (4=50) Max. of (50 demerits) \_\_\_\_\_

Backing during the event (50 demerits) \_\_\_\_\_

Vehicle touches a barrier (excluding base) (50 demerits) \_\_\_\_\_

Actual Time \_\_\_\_\_ Min. \_\_\_\_\_ Sec.

Indicate which flag tip or barrier has been touched

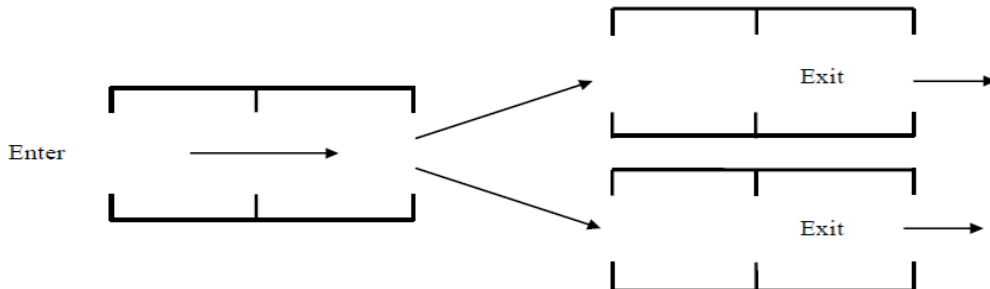

**LAYOUT & DIRECTIONS:**

(Type A bus mirror brackets must higher than 48")

**Setup Tools for Offset Alley:**

- Heavy-duty claw hammer
- 1½ inch masonry nails (one box)
- Two 25 ft. tape measures
- One 100 ft. tape measure
- One 1000 ft. roll of nylon string
- One box of yellow marker crayons
- Carpenter's Square
- Four to Six 10' barriers w/flag tips
- Other

**Single Offset Alley Layout**

Nail # 1 - Starting point.  
Nail # 2 - Stretch string 120' from nail # 1 and tie off.

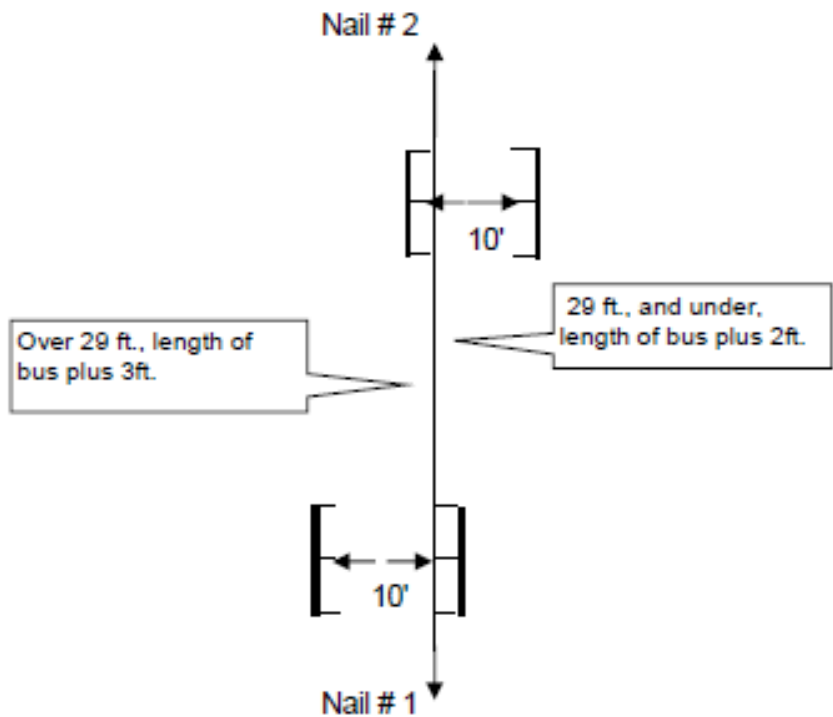

**LAYOUT & DIRECTIONS:**

(Type A bus mirror brackets must higher than 48")

**Double Offset Alley Layout**

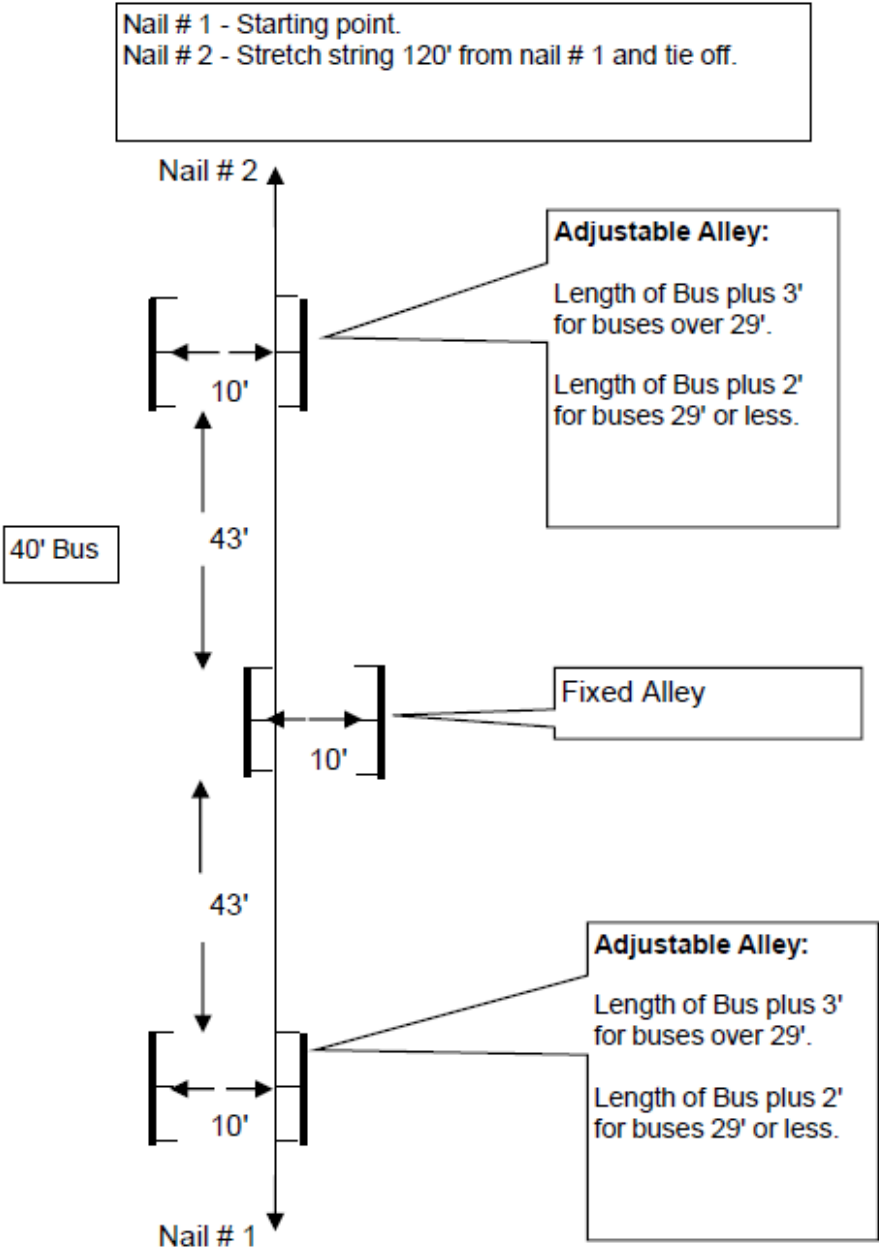

# **RXR GRADE CROSSING - RIGHT TURN EVENT**

Maximum Score: 75 points

## **PURPOSE OF THE EVENT:**

Making a right turn at a railroad crossing represents one of the greatest hazards insofar as mass casualties or fatalities are concerned. This test evaluates the driver's common sense, degree of care and knowledge of the laws, rules and regulations when required to maneuver a school bus across railroad tracks at an intersection. The test also evaluates the driver's ability to make a right turn and determine the clearance of the tracks with the vehicle.

## **INSTRUCTIONS:**

A simulated railroad crossing is laid out as follows:

- A two lane roadway crossing one set of railroad tracks located approximately 50 feet from an intersection.
- Railroad grade crossing signs will be properly positioned to the right side of the roadway in which the driver will make the approach to the intersection.
- The driver will approach the railroad grade crossing giving the correct direction signal and stop as required by law.
- Upon checking the tracks on both directions, the driver will activate the correct turn signal and proceed. The driver shall continue to steer the bus in a straight line until ready to execute the right turn. The point at which the turn begins is determined by the driver's ability to judge a predetermined relationship with the corner (turning point). The turn must be executed without touching the curb line.

**This is a timed event: The contestant will be allowed 15 seconds to complete the right turn.** The time will start when the right rear tire enters or passes the front edge of the entry scoring template and will stop when the right rear tire leaves or passes the rear edge of the recovery scoring template.

The turning radius will be determined on the day of competition.

## ***Scoring***

Drivers are judged from the time they approach the crossing until they complete the right-hand turn. They will be checked on use of directional signals and mirrors, stopping the bus, opening the door and window, checking the tracks in both directions, driving across the railroad tracks, etc. Recommended procedures outlined in "Operation Lifesaver" publications will be used for the basis of scoring:

## **APPROACH THE RXR GRADE CROSSING AND RIGHT TURN:**



**FAILURE TO:**

Complete the event	(75 demerits)
Drive with headlights on or not wearing seat belt	(75 demerits)
Properly use turn signals during the event	(25 demerits)
Stop between 15 and 50 feet from the nearest rail	(75 demerits)
Stop, open door or window (if applicable) at RXR grade crossing	(75 demerits)
Check the tracks in both directions and ensure that it is safe to cross	(75 demerits)
Check left outside mirror(s) before crossing the tracks	(10 demerits)
Check right outside mirror(s) before crossing the tracks	(10 demerits)
Check inside rearview mirror before crossing the tracks	(10 demerits)
Close entrance door	(25 demerits)
Clear back of bus by at least 15 feet from the nearest rail after crossing the tracks	(75 demerits)

**DEMERITS**

**RIGHT TURN:**

**THIS WILL BE A TIMED EVENT. The contestant shall be allowed 15 seconds to complete the right turn.** The time will start when the right rear dual enters or passes the front edge of the entry score template and will end when the right rear tire enters or passes the rear edge of the recovery scoring template.

**Scoring**

Scoring will be based on the method in which the driver enters and recovers from the turn. For scoring purposes, **the outer edge of the tire's tread will be used.** The right rear outside tire must pass through the entire scoring template at the beginning and completion of the turn. Measuring from the curbside of each template, the following demerits shall be charged depending on the travel path of the scoring tire:

- The tire enters and exits the scoring template in the yellow (zero) 0 demerits
- The tire enters and/or exits the scoring template in the black (ten) 10 demerits
- The tire enters and/or exits the scoring template in the red (twenty) 20 demerits
- The tire misses the front edge of the scoring template (twenty five) 25 demerits

The highest value of demerits will be given based on the tires travel through the templates

<b>Red</b>	9" to 12"	<b>20 demerits</b>
<b>Black</b>	6" to 9"	<b>10 demerits</b>
<b>Yellow</b>	0" to 6"	<b>0 demerits</b>

**The tire "does not" pass through the entire template 25 demerits**



Improper use of 8 light "School Bus Flashers"	(25 demerits)
Backs up during event	(75 demerits)



# RXR GRADE CROSSING – RIGHT TURN TEST

Contestant # \_\_\_\_\_

Event Judge \_\_\_\_\_

Maximum Score: 75 points  
 Demerits: \_\_\_\_\_  
 Score Earned: \_\_\_\_\_

## APPROACH THE RXR GRADE CROSSING:

### FAILURE TO:

	(demerits)	<b>DEMERITS</b>
Complete the event	(75 demerits)	_____
Drive with headlights on or not wearing seat belt	(75 demerits)	_____
Properly use turn signals during the event	(25 demerits)	_____
Stop between 15 and 50 feet from the nearest rail	(75 demerits)	_____
Stop, open door or window ( <b>if applicable</b> ) at RXR grade crossing	(75 demerits)	_____
Check the tracks in both directions and ensure that it is safe to cross	(75 demerits)	_____
Check left outside mirror(s) before crossing the tracks	(10 demerits)	_____
Check right outside mirror(s) before crossing the tracks	(10 demerits)	_____
Check inside rearview mirror before crossing the tracks	(10 demerits)	_____
Close entrance door	(25 demerits)	_____
Clear back of bus by at least 15 feet from the nearest rail after crossing the tracks	(75 demerits)	_____

### ENTERING TURN:

**THIS WILL BE A TIMED EVENT. The contestant shall be allowed 15 seconds to complete the turn.**

The time will start when the right rear dual enters or passes the front edge of the entry score template and will end when the right rear tire enters or passes the rear edge of the recovery scoring template.

Scoring will be based on the method in which the driver enters and recovers from the turn. For scoring purposes, **the outer edge of the tire's tread will be used.** The right rear outside tire must pass through the entire scoring template at the beginning and completion of the turn.

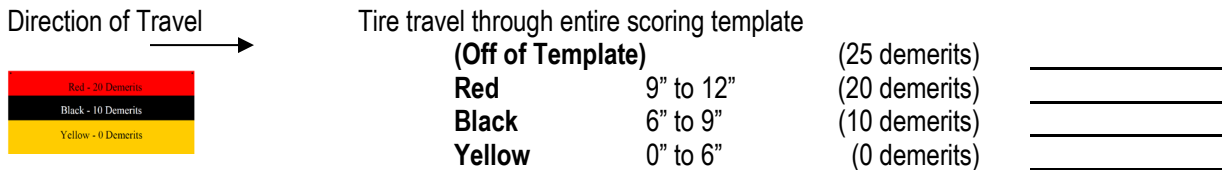

### RECOVERING FROM TURN:

For scoring purposes, **the outer edge of the tire's tread will be used.** The right rear outside tire must pass through the entire scoring template at the beginning and completion of the turn

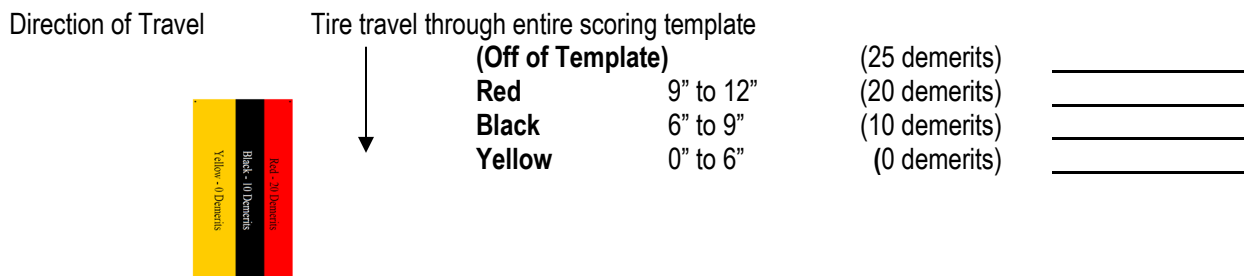

Improper use of 8 light "School Bus Flashers"  
Backs up during event  
Stopping while in turn  
(More than 15 seconds)  
Shifting gears manually while crossing tracks  
Bus stops on tracks

(25 demerits) \_\_\_\_\_  
(75 demerits) \_\_\_\_\_  
(50 demerits) \_\_\_\_\_  
(50 demerits) \_\_\_\_\_  
(75 demerits) \_\_\_\_\_  
(75 demerits) \_\_\_\_\_

**ACTUAL TIME:** \_\_\_\_\_ / \_\_\_\_\_  
                          Min.            Sec.

**LAYOUT & DIRECTIONS:**

**RXR Grade Crossing - Right Turn Template to Template Set-Up  
SAMPLE**

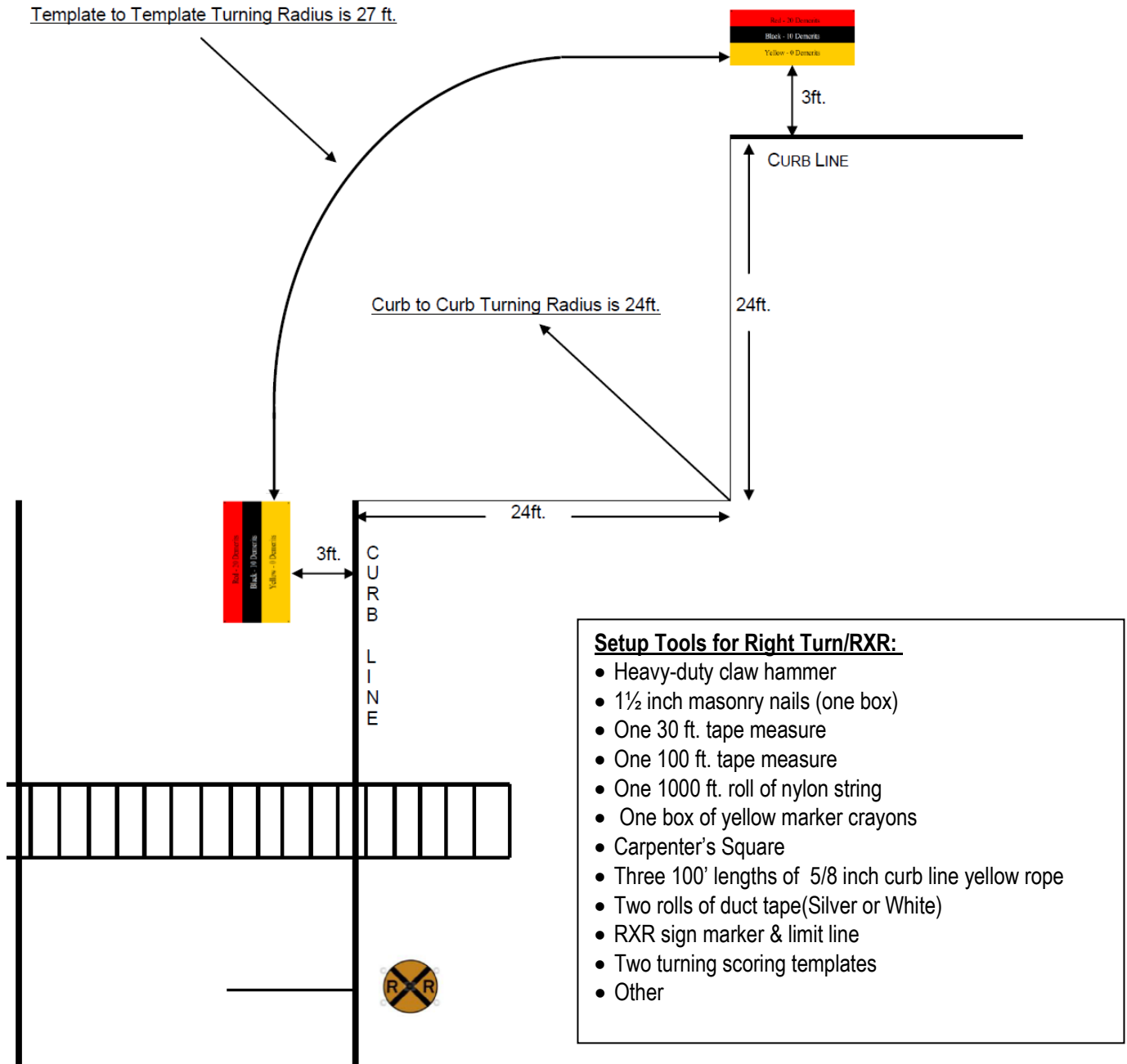

# **STRAIGHT LINE EVENT**

Maximum Score: 50 points

## **PURPOSE OF THE EVENT:**

To determine the driver's ability to maneuver the right wheels of school bus over a straight path of a given width.

## **INSTRUCTIONS:**

The right wheels of the bus must travel the indicated path without striking or moving the markers with any wheel. The bus must be operated in a continuous forward motion. The distance between the markers is the width of the rear duals plus three (3) inches. Measure all right side dual widths. The distance between each set of Tennis Balls is 25 ft. with 4 sets of balls.

## **Scoring:**

For each instance of jerky or uneven movement of bus (Maximum of 20 demerits.)	(2 demerits)
For each instance of stopping forward motion of bus (Maximum of 20 demerits.)	(4 demerits)
Each instance where wheel touches or knocks a tennis ball off (Maximum of 50 points.)	(5 demerits)
Drives either side of pair of tennis ball markers (Maximum of 50 points)	(10 demerit)
Failure to complete the event	(50 demerits)
Failure to wear seat belt	(50 demerits)
Failure to have door closed during event	(50 demerits)
Backing up during event	(50 demerits)
Failure to drive with headlights on	(50 demerits)

# STRAIGHT LINE TEST

Contestant # \_\_\_\_\_

Event Judge \_\_\_\_\_

Maximum Score: 50 points  
 Demerits: \_\_\_\_\_  
 Score Earned: \_\_\_\_\_

## DEMERITS

Each instance of jerky or uneven movement of bus (2) (2) (2) (2) (2) (maximum of 20 demerits)	(2 demerits)	_____
Each instance of stopping forward motion (4) (4) (4) (4) (4) (maximum of 20 demerits)	(4 demerits)	_____
Each instance where wheel <b>touches or knocks</b> tennis ball off (5) (5) (5) (5) (5) (5) (5) (5) (5) (5) (maximum of 50 demerits)	(5 demerits)	_____
Drives to either side of pair of tennis ball markers (10) (10) (10) (10) (10) (maximum of 50 demerits)	(10 demerits)	_____
<b>Failure to:</b>		
Complete the event	(50 demerits)	_____
Wear seat belt	(50 demerits)	_____
Keep door closed during event	(50 demerits)	_____
To drive with headlights on	(50 demerits)	_____
Back up during the event	(50 demerits)	_____



## LAYOUT & DIRECTIONS:

### DIRECTIONS:

1. Measure a 75 ft. straight line and string.
2. Mark the line in intervals of 25 ft. with crayon or chalk.
3. Place a set of tennis balls on holders every 25 ft. Set the base of the ball holder on the outside edge of the string line.
4. Secure the measurement of the right rear duals of all vehicles used in competition. The measurement shall be from bulge to bulge. Tire sizes must be the same type if more than one vehicle type is used.
5. Use the measurement of the duals plus 3" to determine distance between balls.
6. Measure the alignment of the tennis balls from the inside edge of the tennis ball to the inside edge of the other tennis ball.
7. Make a visual check to be sure that there is a perfect straight line with the four sets of tennis balls.
8. Mark the location of the tennis ball holders with crayon or chalk.

### Setup Tools for Straight Line:

- Heavy-duty claw hammer
- 1½ inch masonry nails (one box)
- One 12 ft. tape measure
- One 100 ft. tape measure
- One 1000 ft. roll of nylon string
- One box of yellow marker crayons
- Carpenter's Square
- Ten tennis balls
- Ten tennis ball holders
- Other

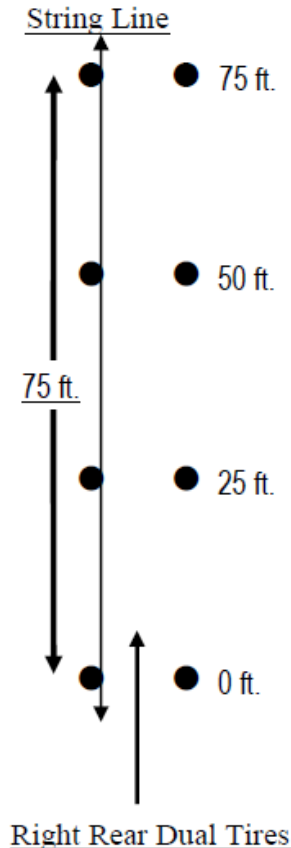

# ***DIMINISHING CLEARANCE EVENT***

Maximum Score: 50 points

## **PURPOSE OF THE EVENT:**

The contestant is required to drive the bus in a straight line with diminishing clearances while driving in a smooth and continuous manner.

## **INSTRUCTIONS:**

For the purpose of conducting this test, five pairs of parallel standards are set up. Each pair of standards, however, is parallel to the next. The distance between each pair of standards is 25 feet. The width of each pair varies as follows:

First pair of standards	Width of bus plus 10 inches
Second pair of standards	Width of bus plus 8 inches
Third pair of standards	Width of bus plus 6 inches
Fourth pair of standards	Width of bus plus 4 inches
Fifth pair of standards	Width of bus plus 2 inches

**Note:** The measurement is from flag tip to flag tip. The alley is set up to allow for the course to diminish equally on both sides.

## ***Scoring***

Contestants will be scored on the following:

Each instance of jerky or uneven movement (Maximum of 10 demerits)	(2 demerits)
Each instance of stopping forward movement of bus (Maximum of 20 demerits)	(4 demerits)
Each instance of bus touching flag tips (Maximum of 50 demerits)	(10 demerits)
Striking standard with bus	(50 demerits)
Failure to complete the event	(50 demerits)
Failure to wear seat belt	(50 demerits)
Backing up during the event	(50 demerits)
Keep door closed during event	(50 demerits)
Failure to drive with headlights on	(50 demerits)

# DIMINISHING CLEARANCE TEST

Contestant # \_\_\_\_\_

Event Judge \_\_\_\_\_

Maximum Score: 50 points

Demerits: \_\_\_\_\_

Score Earned: \_\_\_\_\_

## DEMERITS

Each instance of jerky or uneven movement of bus  
(2) (2) (2) (2) (2) maximum of 10 demerits (2 demerits) \_\_\_\_\_

Each instance of stopping forward motion of bus  
(4) (4) (4) (4) (4) maximum of 20 demerits (4 demerits) \_\_\_\_\_

Each instance of bus touching flag tip  
(10) (10) (10) (10) (10) maximum of 50 demerits (10 demerits) \_\_\_\_\_

Bus strikes flag standard (50 demerits) \_\_\_\_\_

Backing up bus during event (50 demerits) \_\_\_\_\_

**Failure to:**

Complete the event (50 demerits) \_\_\_\_\_

Wear Seat Belt (50 demerits) \_\_\_\_\_

Keep door closed during event (50 demerits) \_\_\_\_\_

Drive with headlights on (50 demerits) \_\_\_\_\_

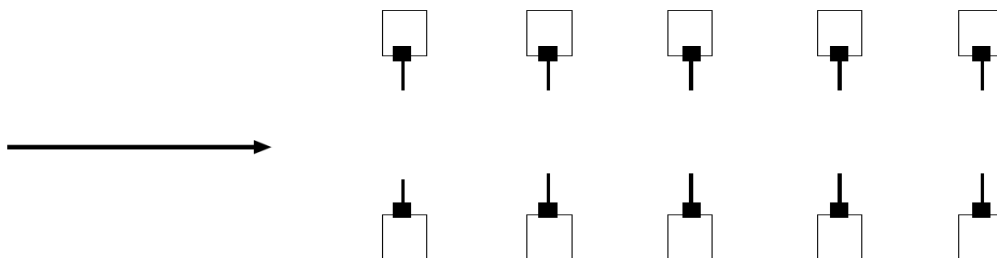



**LAYOUT & DIRECTIONS:**

1. Measure a distance of 100'
2. Mark the measurement at 25' intervals.
3. Place a straight line down with string. Stretch tight.
4. Secure width of buses to be used in competition. Consider rub rails, rubber around tire wells or any other object that will hit the standards such as mirror brackets, etc.
5. Determine the measurement to be used at each diminishing clearance standard.
6. Measure from the center line out to the end of the flag or standard on each side to equal the total measurement. To make sure the measurement is correct, use plumb bob from tip of flag to ground where measurement was made.
7. Do a visual check to make sure that you have a diminishing alley from the perspective of the contestant entering the offset.
8. Mark bases of the standards with crayons or chalk.

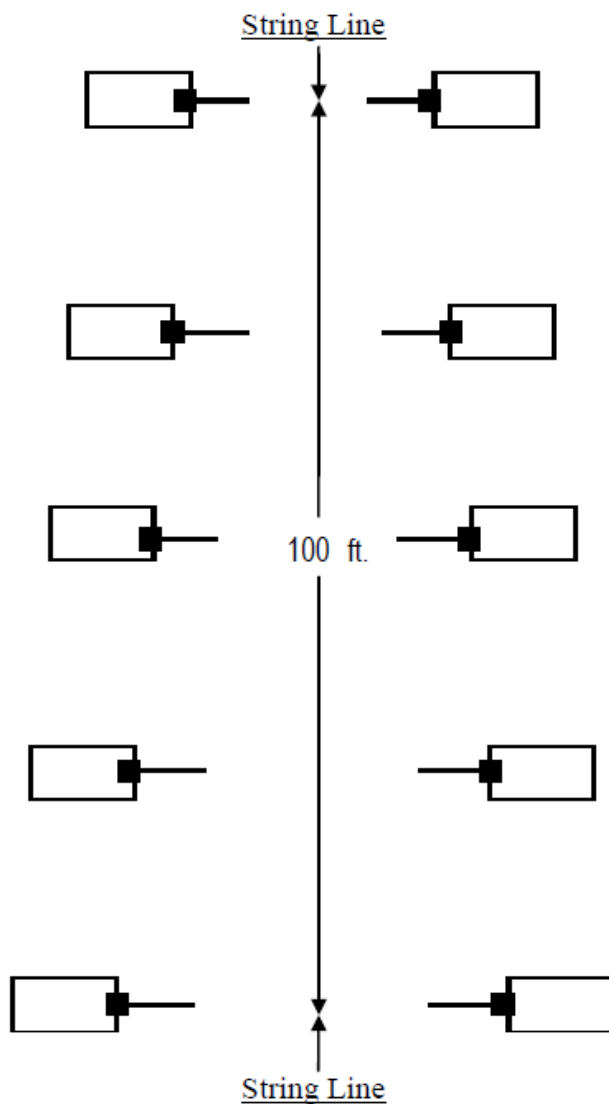

- Setup Tools for Diminishing Clearance**
- Heavy-duty claw hammer
  - 1½ inch masonry nails (one box)
  - One 50 ft. tape measure
  - One 100 ft. tape measure
  - One 1000 ft. roll of nylon string
  - One box of yellow marker crayons
  - Carpenter's Square
  - Plumb bob
  - 10 diminishing clearance standards w/flag arms (36" high minimum)
  - Other

1 <sup>st</sup> pair of standards	With of bus plus 10 inches
2 <sup>nd</sup> pair of standards	With of bus plus 8 inches
3 <sup>rd</sup> pair of standards	With of bus plus 6 inches
4 <sup>th</sup> pair of standards	With of bus plus 4 inches
5 <sup>th</sup> pair of standards	With of bus plus 2 inches

# BACK UP STALL EVENT

Maximum score: 50 points

## PURPOSE OF THE EVENT:

This test is designed to evaluate the driver's ability to back the bus into a stall. A stall the width of the bus plus two (2) feet is provided into which the driver must back their bus into without touching the upright standards and without crossing over the stall limit lines. Depth perception is tested by penalizing the driver for backing up too close to the rear barrier, or parking the bus too far from the rear barrier, or not having the bus centered in the stall (front and rear).

## INSTRUCTIONS:

Two parallel yellow ropes on the ground the width of the bus plus two (2) feet identify each stall. Each front corner of the stall will be marked by upright standards that will not interfere with the backing of the bus. In order to limit the driver's maneuvering room, a front wheel limitation line will be placed on the ground perpendicular to the parallel stall lines. The distance from the front stall standards to the wheel limitation line will be as follows:

Type D - Transit	Length of bus plus 1'
Type C - Conventional	Length of bus plus 4'
Type A - Small Bus	Length of bus plus 4' ( <b>mirror brackets must higher than 48"</b> )

The approach to the back-up stall will be made from the right side only. A three minute time limit starts when the front bumper passes the first upright standard. The bus must be parked in the stall, **with the parking brake set, and the horn sounded, within the three-minute time limit. Each contestant will be permitted one back-up before demerits are charged for excessive backing.**

Upon completion of this event, the bus should be parked as near to the center of the stall as possible. Centering of the bus in the stall will be determined by the relationship of the **center of the front and rear bumpers** the center of the stall, but with only the farthest distance off center (**front or back**) being used to compute demerits.

There will be a one-foot free zone four to five feet in front of the rear barriers in the center of the stall and demerits will be charged if the bus is parked ahead or behind the free zone. After the bus is measured, the contestant will exit the stall between the upright standards.

## **Scoring**

The following are demerits for this event:

Tire tread touches the wheel limitation line	(50 demerits)
Bus touches the front upright standards	(50 demerits)
Tire touches stall sidelines	(50 demerits)
Touching the rear barrier	(50 demerits)
Failure to park the bus, set parking brake and sound the horn within the 3-minute time limit.	(50 demerits)
Failure to pull out between the front upright standards	(50 demerits)
Failure to keep door closed	(50 demerits)
Failure to wear seat belt	(50 demerits)
Failure to drive with headlights on	(50 demerits)
Failure to complete event	(50 demerits)

Per instance of forward motion after the first back-up (not to exceed 42 demerits)	(6 demerits)
Bus parked more than 1 inch off of the center line, front or rear (greatest only)	(2 demerits)
Bus parked forward of 1' free zone and each 6" or fraction thereof, (not to exceed 50 demerits)	(5 demerits)
Bus parked behind 1' free zone and each 6" or fraction thereof (not to exceed 50 demerits)	(10 demerits)

# BACK UP STALL TEST

Contestant # \_\_\_\_\_

Event Judge \_\_\_\_\_

Maximum Score:

50 points

Demerits:

Score Earned:

## DEMERITS

Tire tread touches the wheel limitation line	(50 demerits)	_____
Bus touches the front upright standards	(50 demerits)	_____
Tire tread touches the stall sideline	(50 demerits)	_____
Bus extends into or over rear barrier	(50 demerits)	_____
Failure to pull out between the front upright standards	(50 demerits)	_____
Failure to park bus, set the parking brake and sound horn within three (3) minute time limit (Time starts when front bumper passes upright standard)	(50 demerits)	_____
Each instance of forward motion after the first back up (0) (6) (12) (18) (24) (30) (36) (42) maximum of 42 demerits	(6 demerits)	_____
Bus parked more than 1 inch off of center line each inch or fraction thereof (front and/or rear - greatest only) (2) (4) (6) (8) (10) (12) (14) maximum of 14 demerits	(2 demerits)	_____
Forward of the one-foot free zone-5 demerits for each 6" or fraction thereof (5) (10) (15) (20) (25) (30) (35) (40) (45) (50) maximum of 50 demerits	(05 demerits)	_____
Bus parked behind one-foot free zone-10 demerits for each 6" or fraction thereof (10) (20) (30) (40) (50)	(10 demerits)	_____
<b>Failure to:</b>		
Complete the event	(50 demerits)	_____
Wear seat belt	(50 demerits)	_____
Keep door closed during event	(50 demerits)	_____
Drive with headlights on	(50 demerits)	_____

**ACTUAL TIME:** \_\_\_\_\_ / \_\_\_\_\_  
Min. Sec.

## LAYOUT & DIRECTIONS:

### Setup Tools for Backup Stall

- Heavy-duty claw hammer
- 1½ inch masonry nails (one box)
- One 30 ft. tape measure
- One 100 ft. tape measure
- Two 1000 ft. roll of nylon string
- One box of yellow marker crayons
- One roll of duct tape (Silver or Black)
- Carpenter's Square
- Four 100' lengths of 5/8 inch curb line yellow rope
- Two 25' lengths of 5/8 inch limit line yellow rope
- Two backup stall equipment setups.
- Two timer clocks
- Other



Measure from the center of the front and rear bumper only.  
(DO NOT MEASURE FROM THE CROSSING CONTROL ARM.)

### **Back-Up Stall - 10 Foot Wide Right Side of Bus Approach**

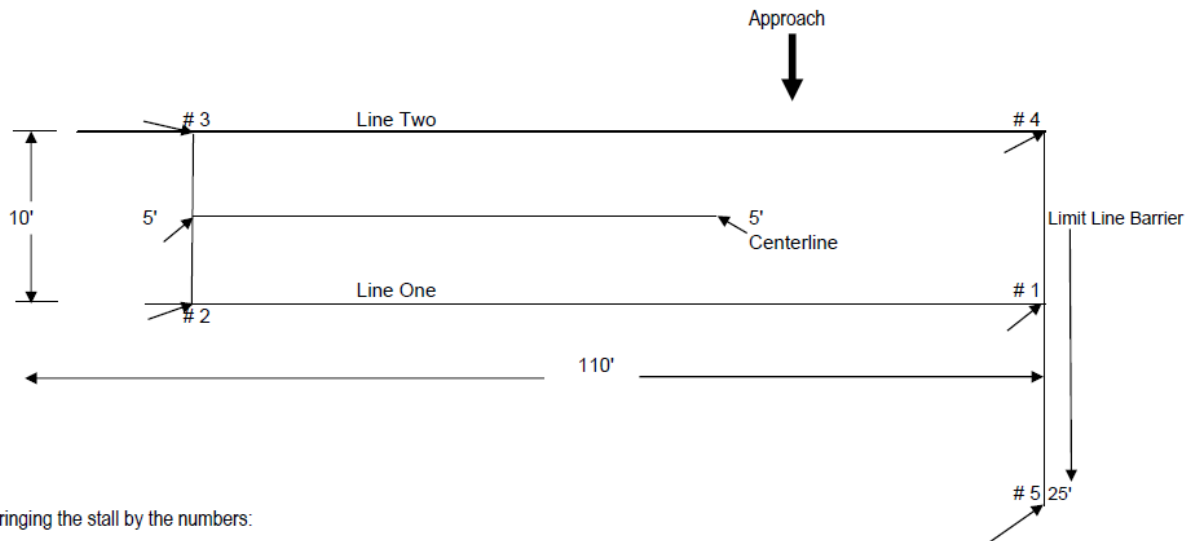

**Note:** Stringing the stall by the numbers:

Nail # 1 - Stall layout starting point.

Nail # 2 - Stretch the string 100' and nail # 2.

Nail # 3 - Measure 10' across, using a 90 degree carpenters square, square the stall using the string and tape measure between # 2 and # 3, when squared, nail # 3. Measure 5' and place nail in center of stall.

Nail # 4 - Stretch the string 100', square the stall using the string between # 1 and # 2, measure 10' and square the stall, nail # 4.

Nail # 5 - Stretch the string 35' aligning with the outside edge of # 1, nail and tie off.

## Back-Up Stall - 10 Foot Wide Right Side of Bus Approach

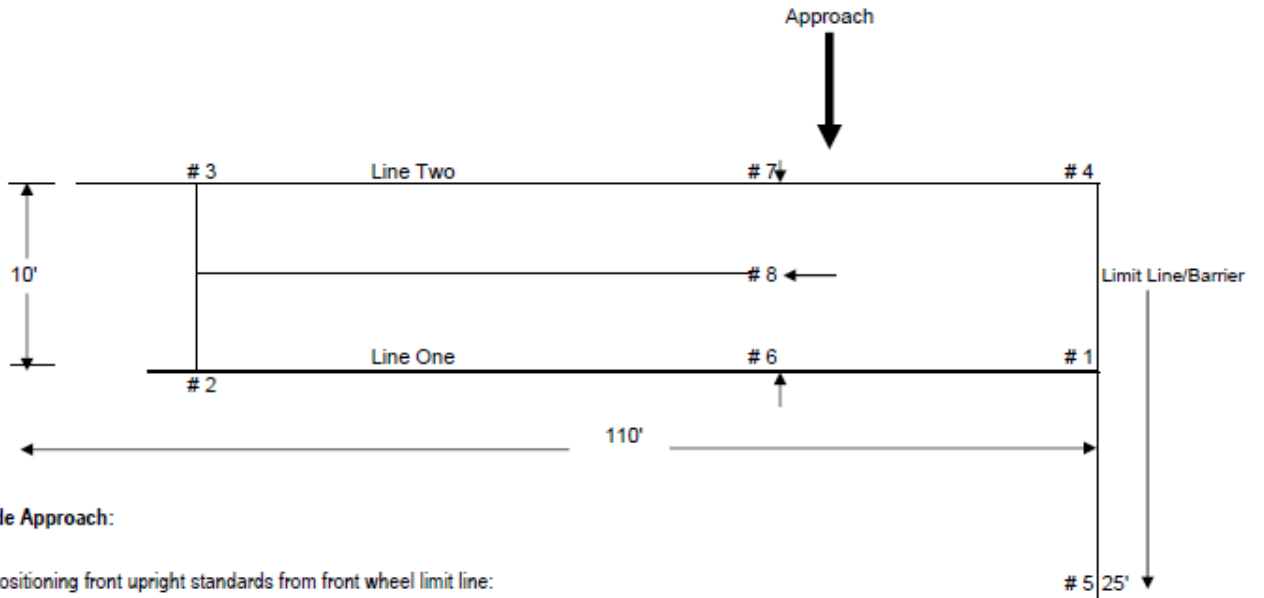

- Mark # 6 - Measure from # 1 using the length of the shortest bus plus 1' to 4' depending on the bus type and place # 6.
- Mark # 7 - Measure from # 4 using the length of the shortest bus plus 1' to 4' depending on the bus type and place # 7.
- Nail # 8 - Measure from the outside edge of # 6 to the outside edge of # 7. Nail # 8 @ 5' the center of the stall.

\*\*\*\*\*

## Back-Up Stall - 10 Foot Wide Right Side of Bus Approach

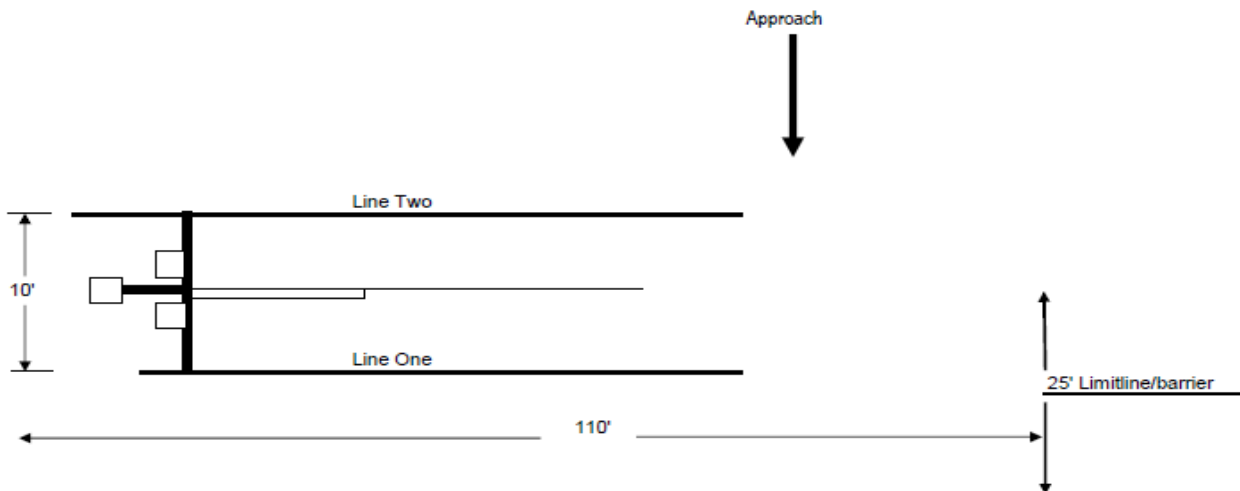

# LEFT TURN EVENT

Maximum Score 50 points

**PURPOSE OF THE EVENT:** This event is designed to determine the driver's ability to properly prepare for, and execute, a left turn.

**INSTRUCTIONS:** A sign indicating "Left Turn" will be placed approximately 150 feet from the beginning of the turn. A lane will be provided in which the driver will make the approach to the corner. The lane is marked on the left with a curb line 50 feet long. The driver will approach the corner giving the correct directional signal at least 100 feet from the turn, as required by law. Each contestant shall continue to steer the bus in a straight line until ready to execute the turn. The point at which the turn begins is determined by the driver's ability to judge a predetermined relationship with the corner (turning point). When this point is reached, the bus should be steered the left. When properly executed, this method of turning left will cause the bus to safely complete the left turn. The bus may not be stopped during this event.

**This is a timed event.** The contestant will be allowed 15 seconds to complete the event. The time will start when the left rear tire enters or passes the front edge of the entry scoring template, and will end when the left rear tire leaves or passes the rear edge of the recovery scoring template.

The turning radius will be determined on the day of competition.

**SCORING:** Scoring will be based on the method in which the driver enters and recovers from the turn. For scoring purposes, **the outer edge of the left outside tire tread will be used.** The left rear outside tire must pass through the entire scoring template at the beginning and completion of the turn. The highest value of demerits will be given based on the tires travel through the entire template. Should the tire enter or leave off the inner or outer side of the template at any time it is to be considered off the template. There is a maximum of 25 demerits per scoring template.

Measuring from the curbside of each template, the following demerits shall be charged depending on the travel path of the scored tire through the entire template.



Yellow	0" to 6"	( 0 demerits)
Black	6" to 9"	(10 demerits)
Red	9" to 12"	(20 demerits)
<b>(Off of Template)</b>		<b>(25 demerits)</b>

## Additional demerits as follows:

<b>10 demerits</b>	Failure to properly activate the left directional signal
<b>10 demerits</b>	Failure to cancel the left directional signal
<b>5 demerits</b>	Each instance of stopping the bus
<b>50 demerits</b>	If any tire touches the curb line at any time
<b>50 demerits</b>	For backing the bus
<b>50 demerits</b>	Failure to complete turn within 15 seconds
<b>50 demerits</b>	Failure to keep door closed during the event

# LEFT TURN TEST

Contestant # \_\_\_\_\_

Event Judge: \_\_\_\_\_

Maximum Score: 50 points  
 Demerits: \_\_\_\_\_  
 Score Earned: \_\_\_\_\_

**ENTERING AND RECOVERING FROM TURN:**

**THIS WILL BE A TIMED EVENT. The contestant shall be allowed 15 seconds.**

The time will start when the left rear outside tire enters or passes the front edge of the entry score template and will end when the left rear outside tire leaves or passes the rear edge of the recovery scoring template.

Scoring will be based on the method in which the driver enters and recovers from the turn. For scoring purposes, **the outer edge of the left outside tire tread will be used.** The left rear outside tire must pass through the entire scoring template at the beginning and completion of the turn.

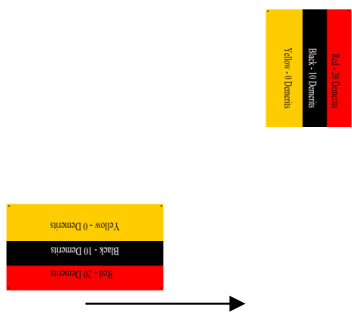
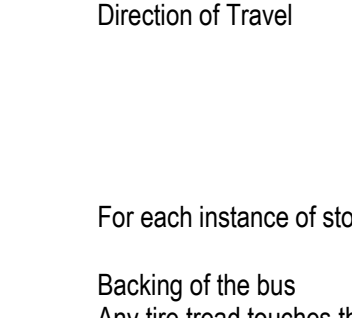
Direction of Travel	Tire travel through entire scoring template	DEMERITS
	Yellow      0" to 6"      ( 0 demerits) Black        6" to 9"      (10 demerits) Red           9" to 12"     (20 demerits) <b>(Off of Template)</b> (25 demerits)	_____ _____ _____ _____
	Tire travel through entire scoring template Yellow      0" to 6"      ( 0 demerits) Black        6" to 9"      (10 demerits) Red           9" to 12"     (20 demerits) <b>(Off of Template)</b> (25 demerits)	_____ _____ _____ _____
For each instance of stopping	(5) (5) (5) (5) (5) (not to exceed 25 demerits)	_____
Backing of the bus	(50 demerits)	_____
Any tire tread touches the curb line	(50 demerits)	_____
<b>Failure to:</b>		
Activate left directional turn signal	(10 demerits)	_____
Cancel left directional turn signal	(10 demerits)	_____
Drive with the headlights on	(50 demerits)	_____
Wear seat belt	(50 demerits)	_____
Keep door closed during the event	(50 demerits)	_____
Complete event within the 15 second time limit	(50 demerits)	_____

**ACTUAL TIME:** \_\_\_\_\_ / \_\_\_\_\_  
   Min.            Sec.



**LAYOUT & DIRECTIONS:**

**Left Turn Template to Template Set-Up**

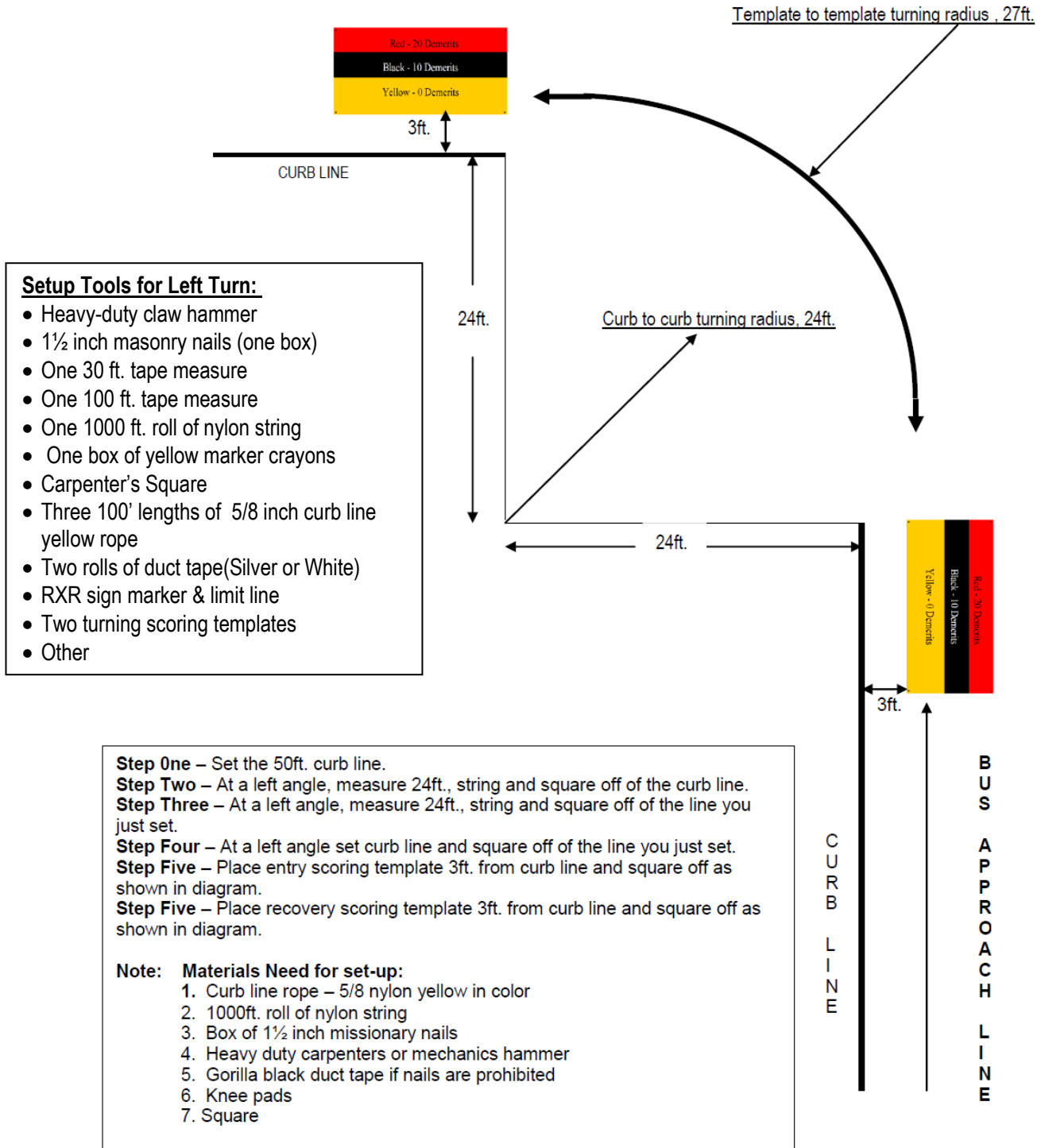

# PARALLEL PARKING EVENT

Maximum Score: 50 points

## PURPOSE OF THE EVENT:

This event is designed to evaluate the contestant's ability to park the bus parallel to a curb without touching barriers placed at both ends of the parking area, without touching the curb and within 18 inches of the curb. It is also designed to judge the contestant's ability to drive the bus out of the parking area without touching the barriers or the curb.

## INSTRUCTIONS:

A section of rope will represent the curb, unless a natural curb is available. Two barriers will be set at right angles to the curb line, extending out eight feet from the curb. The distance between the two barriers will be:

1. For all transits, the length of the bus plus six feet.
2. For all conventional and type A buses the length of the bus plus seven feet. **(mirror brackets over 48 inches)**
3. For all type A buses, the length of the bus plus 8 feet. **(mirror brackets under 48 inches)**

A measurement will be made to determine how close the bus is parked to the curb line, and for determining the number of demerits to be charged. This is a timed event. The contestant is allowed three (3) minutes from the time the front bumper of the bus first passes the rear barrier of approach. The contestant must have the bus parked, set parking brake, and sound the horn within the three (3) minute limit.

Backing in: The contestant will be permitted to back up twice before demerits are charged.

Pulling out: The contestant will be permitted to back up twice before demerits are charged.

**Scoring:** Scoring will be based on the method in which the driver enters and exits a stall.

Failure to park the bus, set parking brake and sound the horn within the three (3) minute time limit	(50 demerits)
Bus touching front or rear barrier at anytime	(50 demerits)
Failure to wear seat belt	(50 demerits)
Keep the door closed during event	(50 demerits)
Failure to drive with headlights on	(50 demerits)
Failure to complete event	(50 demerits)

<b>Score for Backing In:</b>	(50 demerits)
Failure to use right turn signal before entering	(50 demerits)
Tire tread touches curb line	(50 demerits)
For each instance of backing more than twice (not to exceed 25 demerits)	(5 demerits)

<b>Scoring for Zones parallel to curb:</b>		
Zone 1	0" to 3" from curb	(0 demerits)
Zone 2	3" to 6" from curb	(3 demerits)
Zone 3	6" to 9" from curb	(6 demerits)
Zone 4	9" to 12" from curb	(9 demerits)
Zone 5	12" to 15" from curb	(12 demerits)
Zone 6	15" to 18" from curb	(15 demerits)
Over 18" from the curb		(50 demerits)

**Scoring for Pulling Out:**

Failure to use left turn signal	(50 demerits)
Each instance for backing more than twice (not to exceed 25 demerits)	(5 demerits)
Tire tread touches curb line	(50 demerits)
Failure to cancel directional signal	(10 demerits)

# PARALLEL PARKING TEST

Contestant # \_\_\_\_\_

Event Judge \_\_\_\_\_

Maximum Score: \_\_\_\_\_ 50 points  
 Demerits: \_\_\_\_\_  
 Score Earned: \_\_\_\_\_

## DEMERITS

### Entering the Parking Zone

Check each instance of backing the bus and charge 5 demerits each instance over two backs.

(0) (0) (5) (10) (15) (20) (25) not to exceed 25 demerits (05 demerits) \_\_\_\_\_  
 Bus touches any barrier (50 demerits) \_\_\_\_\_  
 Tire tread touches the curb line (50 demerits) \_\_\_\_\_

### Parking Zone Scoring Parallel to Curb:

Zone 1	Bus parked 0"-3"	(00 demerits)	_____
Zone 2	Bus parked 3"-6"	(03 demerits)	_____
Zone 3	Bus parked 6"-9"	(06 demerits)	_____
Zone 4	Bus parked 9"-12"	(09 demerits)	_____
Zone 5	Bus parked 12"-15"	(12 demerits)	_____
Zone 6	Bus parked 15"-18"	(15 demerits)	_____
	Bus parked (over 18" from curb)	(50 demerits)	_____

### Exiting the Parking Zone:

Check each instance of backing up the bus and charge 5 demerits for each instance over two backs.

(0) (0) (5) (10) (15) (20) (25) not to exceed 25 demerits (05 demerits) \_\_\_\_\_  
 Bus touches any barrier (50 demerits) \_\_\_\_\_  
 Tire tread touches the curb line (50 demerits) \_\_\_\_\_

### Failure to:

Park the bus, set the parking brake and sound horn within the 3-minute limit	(50 demerits)	_____
Drive with the headlights on	(50 demerits)	_____
Wear seat belt	(50 demerits)	_____
Keep door closed during event	(50 demerits)	_____
Activate directional signal (entering/exiting)	(50 demerits)	_____
Cancel directional signal	(10 demerits)	_____

**ACTUAL TIME:** \_\_\_\_\_ / \_\_\_\_\_  
   Min.  Sec.

## LAYOUT & DIRECTIONS:

### Setup Tools for Parallel Parking Stall

- Heavy-duty claw hammer
- 1½ inch masonry nails (one box)
- One 12 ft. tape measure
- One 50 ft. tape measure
- One 1000 ft. roll of nylon string
- One box of yellow marker crayons
- Carpenter's Square
- 50' of 5/8 inch curb line yellow rope
- Other

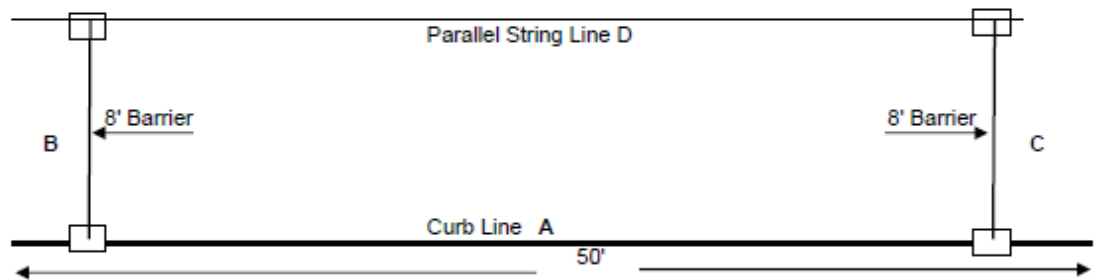

### DIRECTIONS:

1. - Layout the 50' rope curb line "A".
2. - Align the outside edge of the 8' barriers "B" & "C" on curb line "A" at a 90 degree angle.
3. - Layout a parallel string line "D", 8' from curb line "A" at a 90 degree angle to barrier B and C.
4. - Measure and mark along curb line "A" and parallel line "D" the appropriate stall lengths.

#### **Settings for bus stall lengths:**

Transit Bus.....	Length of bus plus 6'
Conventional Bus.....	Length of bus plus 7'
Van type Bus.....	Length of bus plus 7'

5. - Move barrier "B" as necessary for appropriate bus length.

# ***CURB LINE STUDENT LOADING ZONE EVENT***

Maximum Score: 75 points

## **PURPOSE OF EVENT:**

School bus loading **danger** zones present a high risk for school pupils. This procedure can be one of the most lifesaving maneuvers a school bus driver performs. This test is designed to evaluate the driver's alertness to the loading of elementary passengers and to determine their ability to remember and perform several other important functions incidental to such loading. Such items include proper use of directional signals, yellow warning lights, red flashing crossover lights, stop arm deployment and proper mirror use.

## **INSTRUCTIONS:**

A curb line rope, 120 feet in length, to represent the edge of roadway or curb (or if available, an actual curb) will mark the loading zone area. For loading passengers, the contestant will pull into the loading zone. The contestant will utilize the yellow warning lights (100 feet) prior to entering the loading zone. The contestant will then use the red flashing crossover lights and stop arm when stopped to load students.

During the maneuver the contestant will be judged on the bus position in relation to the curb, correct use of directional signals, proper mirror use before and after the stop, proper use of lights, smooth stopping, bus position while stopped, transmission in neutral with parking brake set before door is opened. The contestant must stop the school bus at least 10 feet back, but not more than 15 feet away from student(s).

A measurement will be made at the loading zone area to determine how close the bus is parked to the curb line for determining the number of demerits to be charged.

Scoring demerits for the curb line student-loading zone event are as follows:

## **ENTERING STUDENT LOADING ZONE:**

Backing bus	(75 demerits)
Bus hit barrier	(75 demerits)
Bus Stops more than once between barriers (25 each instance up to)	(75 demerits)
Tire or tire tread touches curb on approach	(75 demerits)

## **FAILURE TO:**

Drive with headlights activated	(75 demerits)
Wear lap/shoulder belts	(75 demerits)
Perform correct mirror check	(50 demerits)
Activate amber warning lights	(75 demerits)
Activate proper directional signal on approach	(75 demerits)
Cancel directional signal	(25 demerits)
Place bus in neutral/park and set parking brake	(75 demerits)
Perform correct mirror check	(50 demerits)
Activate red flashing crossover lights and deploy stop arm	(75 demerits)
Stop at least 10 feet back/away from student (sign)	(25 demerits)
Stop within 15 feet of student (sign)	(25 demerits)
Open service door when safe to do so	(75 demerits)

**BUS MEASURING ZONE FROM CURB OR CURB LINE:**

0" to 12"	(00 demerits)
12" to 18"	(25 demerits)
Over 18 "	(75 demerits)

**EXITING STUDENT LOADING ZONE:**

Bus hits barrier	(50 demerits)
Backing the bus	(50 demerits)

**FAILURE TO:**

Close service door before putting bus in motion	(50 demerits)
Perform correct mirror check	(75 demerits)
Ensure students are safely seated	(75 demerits)
Deactivate red flashing crossover lights	(75 demerits)
Perform additional correct mirror check	(75 demerits)
Activate proper directional signal for departure	(75 demerits)
Cancel directional signal	(25 demerits)
Complete event	(75 demerits)

# CURB LINE STUDENT LOADING ZONE TEST

Contestant # \_\_\_\_\_

Event Judge \_\_\_\_\_

Maximum Score: 75 points

Demerits: \_\_\_\_\_

Score Earned: \_\_\_\_\_

## DEMERITS

### ENTERING / EXITING STUDENT LOADING ZONE:

Backing bus	(75 demerits)	_____
Bus hit barrier	(75 demerits)	_____
Bus Stops more than once between barriers (25 each instance up to)	(75 demerits)	_____
Tire or tire tread touches curb on approach	(75 demerits)	_____

### FAILURE TO:

Drive with headlights activated	(75 demerits)	_____
Wear lap/shoulder belts	(75 demerits)	_____
Perform (5-point) mirror check	(50 demerits)	_____
Activate amber warning lights	(75 demerits)	_____
Activate proper directional signal at least 100 ft. on approach	(75 demerits)	_____
Cancel directional signal	(25 demerits)	_____
Place bus in neutral/park and set parking brake	(75 demerits)	_____
Perform correct mirror check	(50 demerits)	_____
Activate red flashing crossover lights and deploy stop arm	(75 demerits)	_____
Stop at least 10 feet back/away from student (sign)	(25 demerits)	_____
Stop within 15 feet of student (sign)	(25 demerits)	_____
Open service door when safe to do so	(75 demerits)	_____
Close service door before putting bus in motion	(50 demerits)	_____
Perform correct mirror check (5-point)	(75 demerits)	_____
Ensure students are safely seated	(75 demerits)	_____
Deactivate red flashing crossover lights	(75 demerits)	_____
Perform additional (5-point) mirror check	(75 demerits)	_____
Activate proper directional signal before departure	(75 demerits)	_____
Cancel directional signal	(25 demerits)	_____
Complete event	(75 demerits)	_____

### Furthest measurement from curb – front and/or rear:

0" to 12"	(00 demerits)	_____
12" to 18"	(25 demerits)	_____
Over 18 "	(75 demerits)	_____

**ACTUAL TIME:** \_\_\_\_\_ / \_\_\_\_\_  
                             Min.                            Sec.



## LAYOUT & DIRECTIONS:

### Setup Tools - Curb Line Student Loading Zone

- Heavy-duty claw hammer
- 1½ inch masonry nails (one box) or gorilla tape
- One 12 ft. tape measure
- One 100 ft. tape measure
- One 1000 ft. roll of nylon string
- One box of yellow marker crayons
- Carpenter's Square
- 120' of 5/8-inch curb line yellow rope or actual curb
- Other

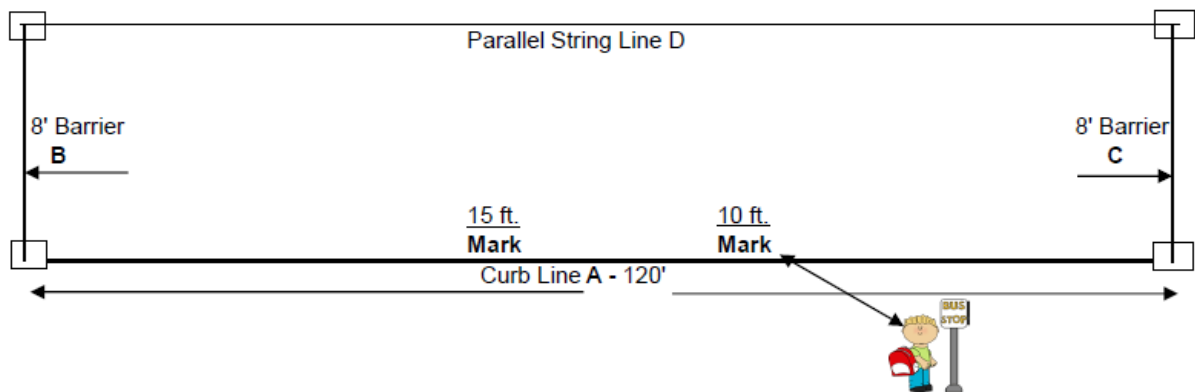

### DIRECTIONS:

1. - Layout the 120' rope curb line "A".
2. - Align the outside edge of the 8' barriers "B" & "C" on curb line "A" at a 90 degree angle.
3. - Layout a parallel string line "D", 8' from curb line "A" at a 90 degree angle to barrier B and C.
4. - Measure and mark along curb line "A" and parallel line "D" the appropriate stall lengths.
5. - Measure and mark along curb line "A" 10 ft. back and away from Student (sign).
6. - Measure and mark along curb line "A" 15 ft. back and away from student (sign).

### **Settings for bus stall lengths:**

Transit Type D Bus..... 3 times the Length of bus  
Conventional Type C Bus..... 3 times the Length of bus  
Van Type A Bus..... 3 times the Length of bus

5. - Move barrier "B" as necessary for appropriate bus length.

# STOP LINE EVENT

Maximum Score: 25 points

## PURPOSE OF THE EVENT:

This test determines the contestant's depth perception, ability to use crossover mirrors and ability to bring the bus to a smooth complete stop.

## INSTRUCTIONS:

A yellow 5/8 inch rope stop limit line six feet long is layout. The contestant should bring the bus to a complete stop as close to the stop limit line as possible. Only one stop will be allowed. The stop limit line may be in sequence with another event, such as the right turn or the railroad grade crossing. The contestant will sound the horn after the stop is made and the vehicle has been placed in neutral gear and the park brake set.

## **Scoring**

Measurement for scoring the stop line will be taken from the front surface of the bumper to the edge of the line closest to the bus. Measurement will be taken any place on the bumper that is the closest to the line. The bus must stop two (2) inches or less from the stop limit line to avoid demerits being given.

0" to 2"	(0 demerits)
over 2" to 4"	(3 demerits)
over 4" to 6"	(6 demerits)
over 6" to 8"	(9 demerits)
over 8" to 10"	(12 demerits)
over 10" to 12"	(15 demerits)
over 12" to 14"	(18 demerits)
over 14" to 16"	(21 demerits)
over 16"	(25 demerits)

Stops with bumper beyond line	(25 demerits)
Failure to complete event	(25 demerits)
Backs up during event	(25 demerits)
Failure to wear seat belt	(25 demerits)
Failure to keep door closed	(25 demerits)
Failure to drive with headlights on	(25 demerits)
Stops more than once	(25 demerits)

### **Setup Tools for Stop Line Event**

- Heavy-duty claw hammer
- 1½ inch masonry nails (one box)
- One 12 ft. tape measure
- One box of yellow marker crayons

## DIRECTIONS:

1. Determine location of stop. Make sure that it does not line up with any ground reference that could be used as a marker.
2. Place a 6 ft. stop line rope on the location determined for the stop line.
3. Place a stop sign on a standard to the right of the line, but not in a location that can be used as a marker or ground reference.

# STOP LINE TEST

Contestant # \_\_\_\_\_

Event Judge \_\_\_\_\_

Maximum Score: 25 points

Demerits: \_\_\_\_\_

Score Earned: \_\_\_\_\_

## DEMERITS

0"-2"	(0 demerits)	_____
Over 2" to 4"	(3 demerits)	_____
Over 4" to 6"	(6 demerits)	_____
Over 6" to 8"	(9 demerits)	_____
Over 8" to 10"	(12 demerits)	_____
Over 10" to 12"	(15 demerits)	_____
Over 12" to 14"	(18 demerits)	_____
Over 14" to 16"	(21 demerits)	_____
Over 16"	(25 demerits)	_____
Stops with bumper beyond stop line	(25 demerits)	_____
Failure to complete event	(25 demerits)	_____
Backs up during event	(25 demerits)	_____
Failure to wear seat belt	(25 demerits)	_____
Failure to keep door closed	(25 demerits)	_____
Failure to drive with headlights on	(25 demerits)	_____
Stops more than once	(25 demerits)	_____

# SURPRISE EVENT

Maximum Score: 50 pts.

The Competition Committee may select a surprise event for the competition. The event would be announced at the Orientation Meeting on Saturday evening. The event would be designed to test the ability of a driver to react to an unplanned event.

# BUS MEASURING POINTS:

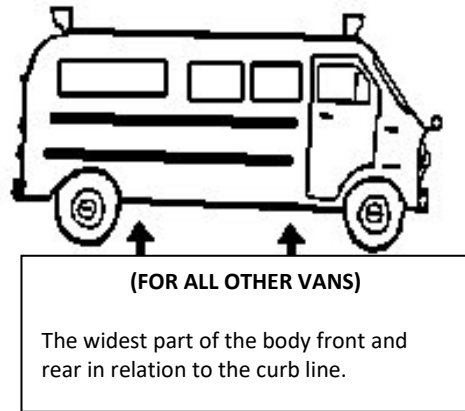
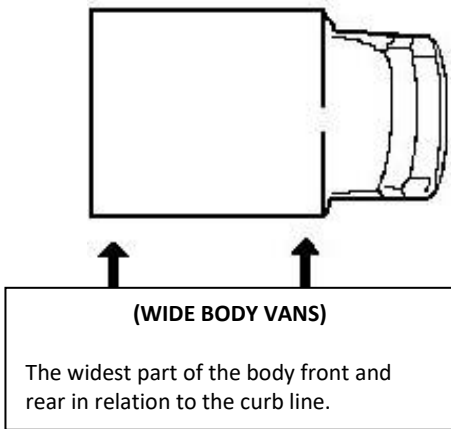
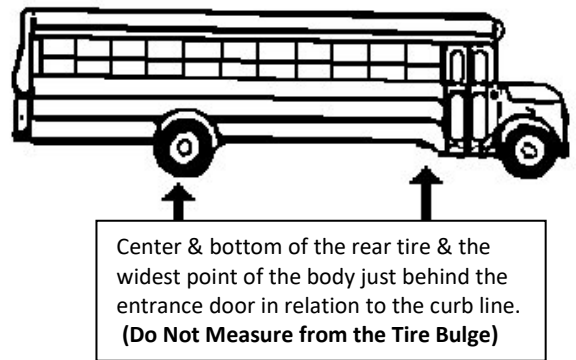
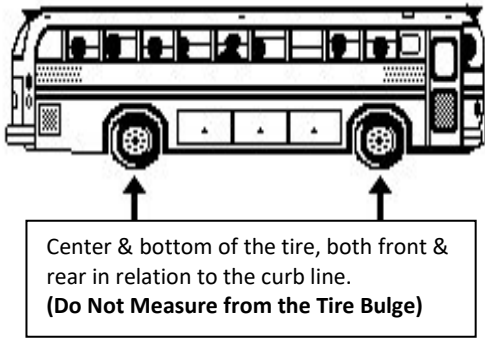

## How to use the measuring device

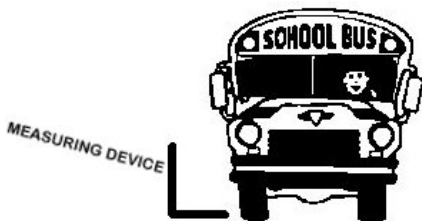

Measuring from the center of the tire tread

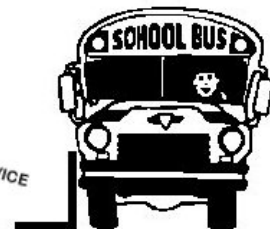

Measuring from the body

**For Events:** Parallel Parking and Curb line Parking

**School Bus Driver International Safety Competition  
Grand Champions**

1971	Larry Beckstrom, California	2001	Jerry Kinney, Michigan – Conventional David Martin, Oregon – Transit Larry Hannon, Pennsylvania – Small Bus
1972	Roger Sill, California		
1973	Dan Perry, California		
1974	Roger Sill, California		
1975	Bob Ives, Kansas	2002	Bob Drouin, Ontario, Canada – Conventional Brent Carman, California – Transit Suzanne Gettings, New York – Small Bus
1976	James McKeel, Kansas		
1977	Nelson Benedict, Ohio		
1978	J. Burton Haerr, III, Ohio		
1979	Bob Ives, Kansas	2003	Mark Corker, Kansas – Conventional Brent Carman, California – Transit Bob Hutson, Kansas – Small Bus
1980	George Powell, New Mexico		
1981	Sarah Fanton, Massachusetts		
1982	Ruth Hatfield, West Virginia	2004	Melvin Meinhart, Colorado – Conventional Osgood Simpkins, Virginia – Transit James Huddleston, Kentucky – Small Bus
1983	Ron Peterson, Kansas		
1984	Alex MacDonald, Washington		
1985	Darrel Wagoner, West Virginia		
1986	Ranell Tyler, Texas	2005	Larry Hannon, Pennsylvania – Conventional Osgood Simpkins, Virginia – Transit Bob Hutson, Kansas – Small Bus
1987	Nick Darnell, Ohio		
1988	Donald Edwards, Pennsylvania	2006	Larry Hannon, Pennsylvania – Conventional Dana Opp, Michigan -- Transit Jaye Jaye Knickelbein, Kentucky – Small Bus
1989	Larry Hannon, Pennsylvania		
1990	Sylvia Swords, Texas		
1991	Phyllis Meides, New York		
1992	Don Hawkins, New Hampshire		
1993	Roger Kerns, Kentucky		
1994	Don Hawkins, New Hampshire - Conventional Kent Hawkins, Utah – Transit	2007	George Sovers, Pennsylvania – Conventional Alfred Boyce, Colorado – Transit Jaye Jaye Knickelbein, Kentucky – Small Bus
1995	Don Hawkins, New Hampshire – Conventional Jack Clary, Washington – Transit		
1996	Lawrence Hannon, Pennsylvania – Conventional Kent Hawkins, Utah – Transit	2008	Cindy Shipley, Colorado – Conventional Chris Fritz, Colorado – Transit Brent Carman, California – Small Bus
1997	Bob Carroll, Florida – Conventional Kent Hawkins, Utah – Transit	2009	Larry Hannon, Pennsylvania – Conventional Danny Mack Stegall, Missouri – Transit Brandy Ellen Acevedo, California – Small Bus
1998	Shirley Miller, Texas – Conventional John L. Martin, California – Transit Debra Huntington, New York – Small Bus	2010	Larry Hannon, Pennsylvania – Conventional Mark Miller, Washington – Transit Richard Hall, Kentucky – Small Bus
1999	Patti Cox, Georgia – Conventional John Cain, California – Transit Lynn White, Ontario, Canada – Small Bus	2011	Larry Hannon, Pennsylvania – Conventional Mark Miller, Washington – Transit Russell Altizer, Virginia – Small Bus
2000	James L. Roark, II, Florida – Conventional Brent Carman, California – Transit Lynn White, Ontario, Canada – Small Bus	2012	Mark Koelbl, Canada – Conventional Antonio Perez, California – Transit Russell Altizer, Virginia – Small Bus

2013	Larry Hannon, Pennsylvania – Conventional Antonio Perez, California – Transit John Labus, West Virginia – Small Bus
2014	Ed Rollins, West Virginia – Conventional Mark Miller, Washington – Transit Russell Altizer, Virginia – Small Bus
2015	Bill Wiseman, West Virginia - Conventional Victor Garza, California - Transit Mary Slate, West Virginia – Small Bus
2016	Kristina Raley, Texas - Conventional Mark Miller, Washington - Transit Virginia Smythe, Oregon – Small Bus
2017	Billy Wiseman, West Virginia - Conventional Hanna Beard, Missouri, Transit David Mansfield, Minnesota, Small Bus
2018	Larry Hannon, Pennsylvania – Conventional Victor Garza, California – Transit Josh Simpkins, Virginia – Small Bus
2019	Billy Wiseman, West Virginia – Type C Bus Mark Miller, Washington – Type D Bus John Labus, West Virginia – Type A Bus
2024	Wanda VanZonnevald, Colorado – Type C Bus Mark Miller, Washington – Type D Bus Dorothy Dorman, Kansas – Type A Bus